

Waterhammer analysis of Sulaibiya Wastewater Treatment and Reclamation Plant

assignment

On March 25th 2003, Ionics Italba S.p.A. commissioned WL | Delft Hydraulics to perform a dynamic hydraulic analysis of the Sulaibiya Wastewater Treatment and Reclamation Plant in Kuwait. The plant consists of an ultra filtration system (UF) and a reverse osmosis system (RO). With a maximum feed capacity of 22,032 m³/h of brackish water, the Sulaibiya Wastewater Treatment and Reclamation Plant is the world's largest membrane-based water reclamation facility. The facility produces 18,720 m³/h fresh water for agriculture purposes.

The aim of the study is to verify the proper working of the complete plant for all relevant operating conditions and emergency situations and to advice on alternative operating procedures and measures. The proper working is defined based on allowable pressure in the skid. The surge analysis evaluates whether all main piping systems fulfil the maximum and minimum allowable pressure rating of the involved pipe under normal and emergency operating conditions, such as pump switches, valve closure or power failure scenarios.

WANDA, the validated computer program for hydraulic design and dynamic analysis of pipeline design developed by WL | Delft Hydraulics, has been used for all hydraulic calculations. Three models were built: the UF feed model (normal operation), the UF backwash model and the RO model. 7 steady state cases and around 30 unsteady state cases have been simulated.

client

Ionics Italba S.p.A, Milano Italy

period

March 2003 – February 2004



Reverse Osmosis vessels

keywords:
waste water treatment
pressure surge analysis
control systems
ultrafiltration
reverse osmosis

The UF-system

The Ultra Filtration (UF) system consists of five trains fed by six pumps via one common header, and one stand-by pump (see figure 1 and 2). Three trains (train B, C and D) consist of 14 skids each, two trains consist of 13 skids each (train A and E). The filtrated water is collected in the UF Backwash water basins. Because the UF-system consists of five UF trains each consisting of repeating sub-systems, only one train is modelled in detail (train B). The hydraulic behaviour of the simplified parts is modelled in a way that most essential hydraulic properties such as storage volume, inertia, head loss and hydraulic stiffness are included. These properties are responsible for the damping behaviour of a pressure surge. The possible consequences of pressure surge reflections are checked.

Each skid consists of several membrane vessels. The maximum allowable under pressure in the skids is -0.2 barg. The head loss over the entire skid depends on the status of the skid (dirt collection). On top of each skid 4 small vent valves are present. These valves can open very fast to let in air or expel water. Flow control valves upstream of the skids control the discharge distribution in the system. Downstream of the skid the water enters the permeate line and flows towards the reclaimed water basin.

Figure 1: Schematisation of the Ultra Filtration system

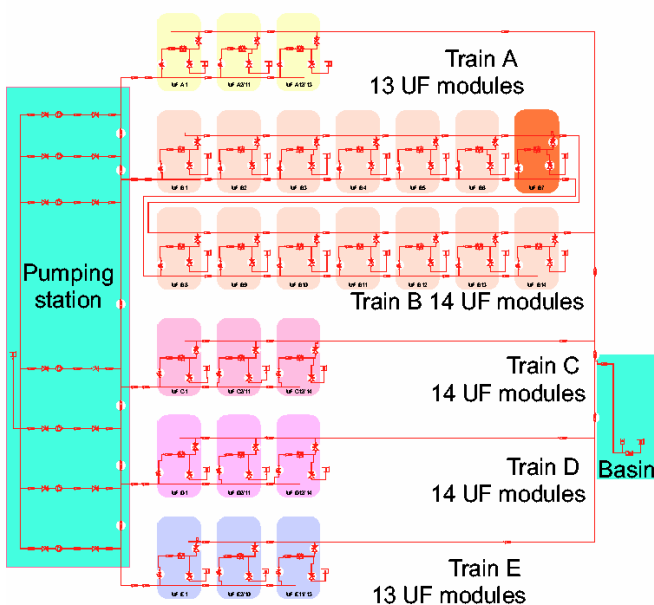

Results UF-system

In the steady state, the minimum over pressure in the skids is small. The distance between the skids and the pumps is short, thus an under pressure wave caused by a pump trip reaches the first skid almost immediately after a pump trip.

It was not possible to use air vessels to prevent unallowable under pressures in the skids. Therefore, the solution had to be found in operating conditions.

Among the cases studied, was an electric power failure (emergency situation), which results in a full pump trip (FPT). The valves downstream of the pumps are fail close. In reaction to this FPT the vent valves on top of all skids open immediately after a FPT, in order to prevent the skids from unallowable under pressures (see figure 5 and 6). Furthermore, the valves downstream of the skid are slowly closed, to prevent the vent valves from filling large parts of the system with air. This operation sequence leads to acceptable pressures in the entire system.

Ultra Filtration skids

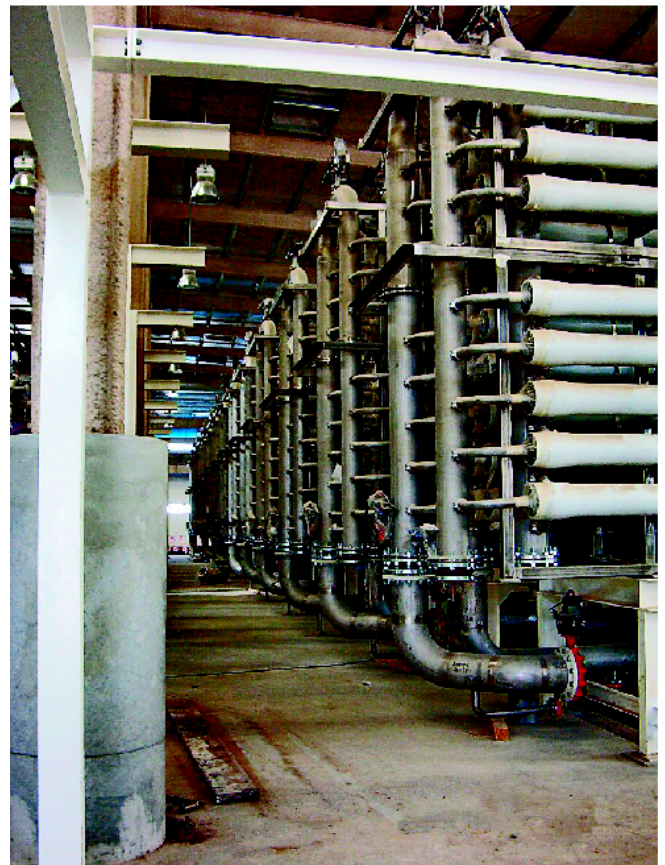
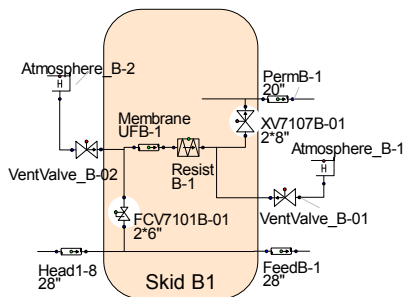

Figure 2:
Schematisation of a skid



The RO-system

The RO plant consists of 6 trains, each train having three stages, see also figure 3. The first stage consists of four pumps feeding four RO-skids from the same reservoir. Downstream of the skids, the permeate flow (50% of the feed flow) is conveyed to the permeate header, whereas the brine flow (also 50% of the feed flow) is conveyed to the second stage. The second stage consists of two pumps feeding two RO-skids. In addition, here 50% of the feed is permeate flow, which is conveyed to the permeate header and 50% of the feed is brine. The brine flow is conveyed to the third stage. The third stage consists of one pump feeding one skid. Here, 40% of the feed is permeate, while 60% of the feed is brine. A valve downstream of the third stage skid maintains a constant flow rate. The overall brine flow is 15% of the total flow. Downstream of the permeate header, CO₂ strippers are located.

The osmotic pressure causes a different relation between pressure and flow than one would expect based on hydraulics. If the pressure difference between feed and permeate has decreased below the osmotic pressure, a reverse flow in the permeate line occurs.

Therefore, for this project, a new WANDA component has been developed called the R(everse)O(smosis)resist. It describes the behaviour of the flow rate from the feed to the permeate side of the RO vessel. The value of the osmotic pressure is a property that gives the head loss over the ROresist, where the flow rate is zero. Furthermore, the resistance of the ROresist is linear to the flow rate.

Figure 3:
Schematisation of the Reverse Osmosis

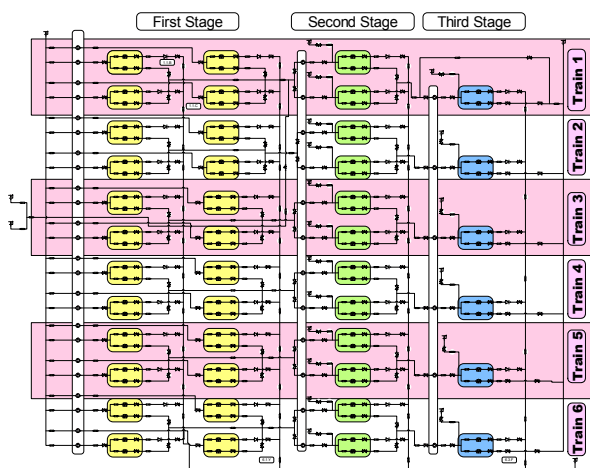

Overview of Ultra Filtration skids

Results RO-System

One of the cases analysed was the pump trip of all first stage pumps ($t=0s$), followed by the closure of the valves to the feed, permeate and brine line ($t=1s$), the trip of all second stage pumps ($t=2s$) and third stage pumps ($t=4s$).

The newly developed ROresists functioned correctly in the simulations. Figure 4 shows the pressure difference over and the discharge through one of the ROresists. The osmotic pressure of the ROresist is 30 m. After 1.7 seconds the pressure difference between feed and permeate drops below the osmotic pressure, but remains positive. However, at that moment the discharge through the ROresist becomes negative.

Figure 4: Results of the simulation

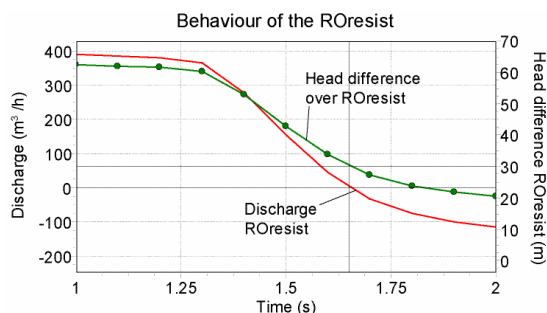

UF-system in backwash

Every 24 minutes the skids need a backwash, which takes 40 seconds. For the backwash flow condition of the UF system a separate model is made. Five pumps, for each train one, are used to clean the UF system. At most, one skid can be in backwash per train. When the UF system is in backwash operation, the maximum flow rate through a skid is approximately 4 times larger than when the UF system is in UF operation.

Results UF-system in backwash

For the Backwash flow condition, also an electric power failure was simulated. Again, the FPT was followed by the opening of the vent valves and the closure of the valve downstream of the skid (figure 5 and 6).

Here also, this sequence led to satisfying results.

Figure 5: Vent valve discharge

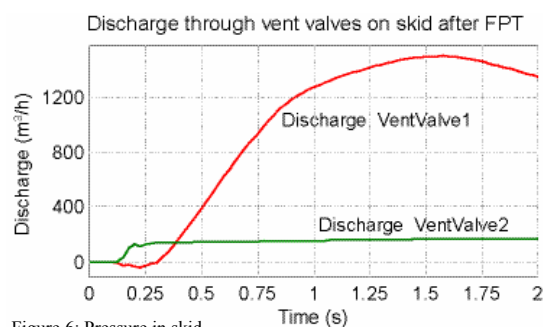
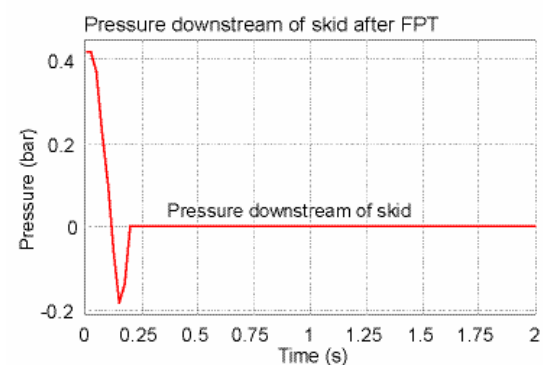

Figure 6: Pressure in skid



For more information contact:

Ruud.Lemmens@wldelft.nl
Christof.Lubbers@wldelft.nl

WL | Delft Hydraulics

Decisive advice: from multidisciplinary policy studies to design and technical assistance on all water-related issues.

Rotterdamseweg 185
p.o. box 177
2600 MH Delft
The Netherlands
telephone +31 15 285 85 85
telefax +31 15 285 85 82
e-mail info@wldelft.nl
internet www.wldelft.nl